



1-800-779-2102

Mon – Thurs: 8:00am - 5:00pm | Friday: 8:00am - 4:00pm CST

**INSPECT YOUR PRODUCT FOR DAMAGE & MISSING
PARTS BEFORE PROCEEDING TO INSTALLATION**

PROCEDURE FOR RETURNS OR MISSING HARDWARE

-PLEASE CONTACT THE ORIGINAL POINT OF PURCHASE FOR:
SHIPPING DAMAGE, RETURNS, OR WARRANTY CLAIMS

-CONTACT DEE ZEE DIRECTLY FOR MISSING PARTS OR HARDWARE

WWW.DEEZEE.COM

REGISTER YOUR PRODUCT ONLINE: www.deezee.com/registration

VIEW INSTRUCTIONS ONLINE: www.deezee.com/instructions

⚠ WARNING: Cancer and Reproductive Harm
www.P65Warnings.ca.gov

Operating, servicing, and maintaining a passenger vehicle can expose you to chemicals such as lead, phthalates, engine exhaust, and carbon monoxide that are known to the State of California cause cancer and birth defects or other reproductive harm. To minimize exposure, service your vehicle and its accessories in a well-vented area and wear gloves or wash your hands frequently.



DEE ZEE, INC. WARRANTY AGREEMENT

Dee Zee, Inc. guarantees the original purchaser a limited lifetime warranty against manufacturer defects in materials, workmanship, and design under normal use, excluding damage resulting from road hazards such as gravel or other debris, product misuse, improper installation, impairments from accidents, product modifications, improper repairs, spills, vandalism, product neglect, or acts of God.

This warranty applies only to the original purchaser of new product(s) and is limited to the replacement of genuine Dee Zee products. Modification of any kind to Dee Zee products voids all warranty coverage. Warranty does not include electrical components, installation, cost of removal, labor, transportation costs, loss of use, inconvenience, or consequential damages.

WARRANTY COVERAGE - MATERIALS & WORKMANSHIP

LIMITED LIFETIME WARRANTY:

- STAINLESS STEEL: Side Steps, Grill Guards, Bull Bars, Bed Caps, and Side Rails
- ALUMINUM: Side Steps, Running Boards, Storage Boxes, Transfer Tanks, Bed Protection, Side Rails, Invis-A-Racks, and Cab Racks
- PLASTIC: Storage Boxes
- OTHER: Front and Rear Bumpers

THREE-YEAR WARRANTY:

- POWDER-COATED / E-COATED STEEL: Side Steps, Running Boards, Storage Boxes, Transfer Tanks, Cab Racks, Sport Bar Ladder Racks, Cargo Carriers, Mounting Brackets (NX, Rough Step, and Bumper Guards only)
- OTHER: Tailgate Assist, Bed Mats, Floor Mats, Auxiliary Fuel Connection Kits, and All Products Not Otherwise Listed Individually

WARRANTY COVERAGE – FINISH PROTECTION

The finish of all Dee Zee products is covered for one-year (1) from the date of purchase. Dee Zee products have a high quality finish that must be cared for and maintained like any other exposed finish on the vehicle. Protect the finish with non-abrasive automotive wax (e.g. Pure Carnuba) on a regular basis. Applying soaps, polishes, or waxes that contain an abrasive compound may scratch the finish and leave the exposed material susceptible to corrosion.

WARRANTY COVERAGE – COMPONENT PARTS

Operational items such as shocks, latches, hinges, and wear items including, but not limited to, mud flaps, step pads, toolbox tray, end caps, hardware, seals, etc. have a one-year (1) warranty. Replacement component parts can be ordered via credit card (MasterCard or VISA) by calling 1-800-779-2102. All replacement parts are non-returnable and non-refundable.

GPI® FUEL PUMPS & ACCESSORIES

All Great Plains Industries (GPI) products, including transfer tank pumps and fuel meters are covered by GPI's warranty policies. Dee Zee's warranty terms do not apply to GPI products. To submit a warranty claim, please contact GPI at 1-800-835-0113 or visit www.gpi.net.

WARRANTY SUBMISSION PROCEDURE

All warranty claims will be initiated at the place of purchase. The original purchaser will be required to present the original sales receipt with purchase date shown and provide photographs of the defect.

In the event the originally purchased product style is no longer available, Dee Zee will warranty the defective part with a current equivalent. If a comparable product is no longer available, the product would be returned to the store of purchase for a refund or the applicable cost difference can be paid to choose an alternate style.

DISCLAIMER

All products are sold as appearance accessories and should not be relied upon as protection for the vehicle or its occupants in the event of an accident. Vehicles equipped with a supplemental restraints system (air bags) deployed by impact and collision avoidance systems should not be modified in any way. Always consult the vehicle manufacturer if you have any questions regarding supplemental restraint systems and sensors.

Buyer must accommodate front and rear sensors during product installation and assumes all risk should these be tampered, rerouted, severed, or disconnected. This includes disabling visual, audio, or vibration alerts into the cab. Buyer assumes all risk and responsibility for wiring any supplemental auxiliary lights.

Buyer assumes all risk, liability, and cost for the installation and use of Dee Zee products. Dee Zee, Inc. assumes no liability for injury, loss, incidental or consequential damages in the event of an accident.



Thank you for choosing Dee Zee to add function and accessorize your vehicle. Dee Zee has been a staple brand in the truck accessory market since 1977 and we hold a reputation of quality manufacturing based in America's Heartland. Our products are born through careful engineering and backed by industry leading warranty programs. We appreciate the opportunity to serve you and your vehicle!

Review the instruction pages in their entirety to prepare the required tools

Warning: Please check for wiring or other obstructions before drilling any holes in the vehicle. If it is necessary to drill any holes, Dee Zee recommends putting a sealant or rust inhibitory around all holes drilled into the body of the vehicle.

It is the sole responsibility of the vehicle owner to check for tire clearance. It is unlawful and dangerous to ride on any external vehicle step while the vehicle is in motion.

Cleaning: To be entitled to all warranty rights offered with the product, Dee Zee steps need to be cleaned regularly with a mild detergent. Do NOT use abrasive cleaners. For stainless steel products, the application of a high grade automotive wax is recommended.





Dee Zee Cares - Please Recycle

For an electronic version of these instructions visit: www.deezee.com/instructions

Register your product online: www.deezee.com/registration

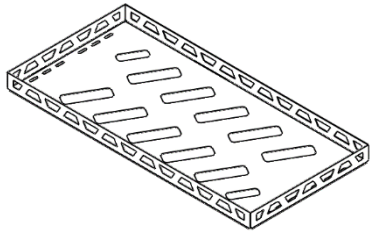
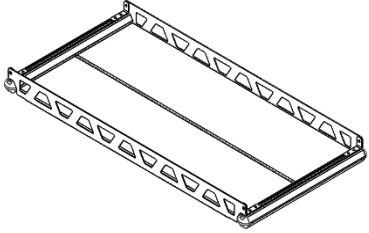
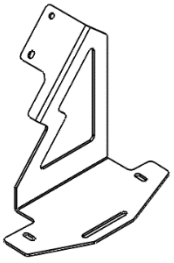
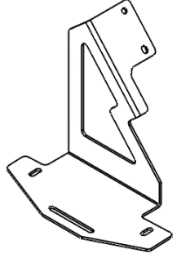
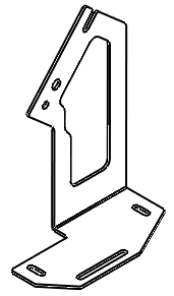
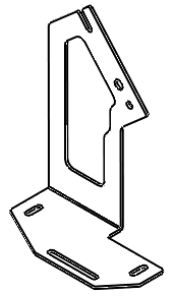
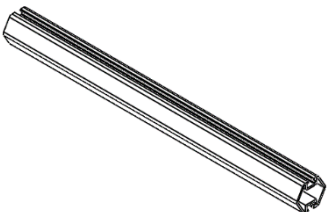
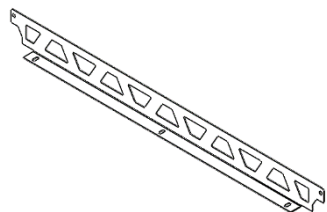
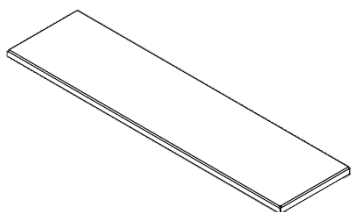
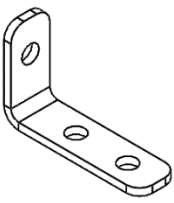
Jeep Cargo Rack Installation Instructions
DZ 4468JK Jeep Wrangler JK 2007-2018, DZ 4468JL Jeep Wrangler JL 2019-Current
DZ 4470JP Steel Cargo Rack, DZ 4471JP Bolt Together Cargo Rack

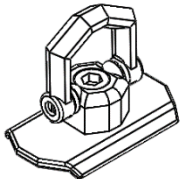
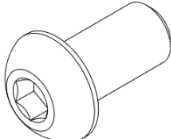
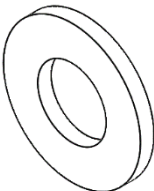
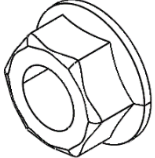
<p>A Steel Cargo Rack</p>  <p>DZ 4470JP X1</p>	<p>B Bolt Together Cargo Rack</p>  <p>DZ 4471JP X1</p>	<p>C JK Driver Mounting Bracket</p> <p>Only used on JK</p>  <p>B 2689LP X1</p>
<p>D JK Passenger Mounting Bracket</p> <p>Only used on JK</p>  <p>B 2689RP X1</p>	<p>E JL Driver Mounting Bracket</p> <p>Only used on JL</p>  <p>B 2690LP X1</p>	<p>F JL Passenger Mounting Bracket</p> <p>Only used on JL</p>  <p>B 2690RP X1</p>
<p>G 20" Hex Tube</p>  <p>JPCR004P DZ 4471JP X2</p>	<p>H Rack Fence</p>  <p>JPCR003P DZ 4471JP X2</p>	<p>I Rack Deck</p>  <p>JPCR002P DZ 4471JP X2</p>
<p>J L Bracket</p>  <p>B 2523P DZ 4471JP X4</p>	<p>K Small Hex Endcap</p>  <p>EC DZE-581ASSM DZ 4471JP X4</p>	<p>L Hex Series Tie Downs</p>  <p>DZ 99700TB DZ 4471JP X2</p>
<p>M M8-1.25X16mm Button Head Bolt</p>  <p>PN 1261 DZ 4470JP X4 DZ 4471JP X14 DZ 4468JL X4</p>	<p>N M8 Washer</p>  <p>PN 647B DZ 4470JP X4 DZ 4471JP X14 DZ 4468JL X4</p>	<p>O M8 Hex Flange Nut</p>  <p>PN 526 DZ 4470JP X4 DZ 4471JP X14</p>

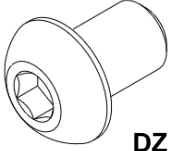
P**M8-1.25X12mm Button Head Bolt**

PN 1260

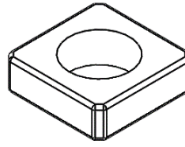
DZ 4470JP X4
DZ 4471JP X12**Q****M8 Square Nut**

PN 1262

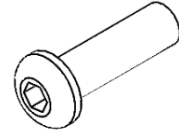
DZ 4470JP X4
DZ 4471JP X12**R****M6-1.0X20mm Button Head Bolt**

PN 649B

DZ 4468JK X4

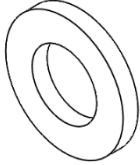
S**M6 Washer**

PN 645B

DZ 4468JK X4

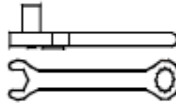
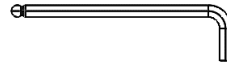
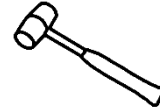
Required ToolsWrench
13mmAllen Wrench
4mm
5mm
6mm

Rubber Mallet

Straight Blade
Screwdriver**1**

This step is for JK only, if you have a JL skip to step 3. First undo the Velcro on the roll cage cover on the driver's side in the cargo area shown below to find the threaded holes.

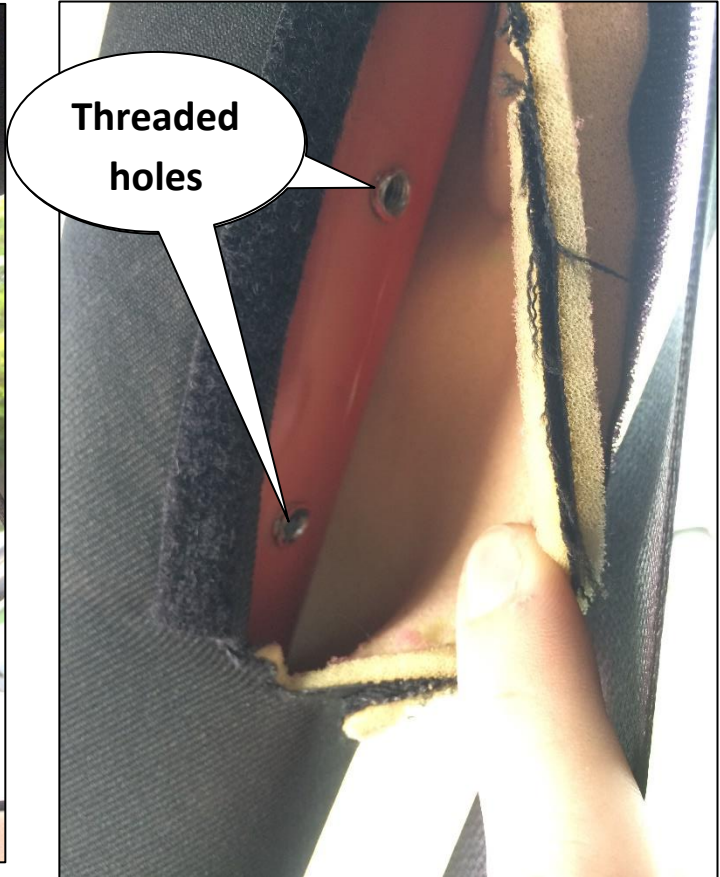

2 Install bracket (C) using bolts (R) and washers (S) into the threaded holes found in the previous step. Repeat steps 1&2 on the passenger side using bracket (D) instead.

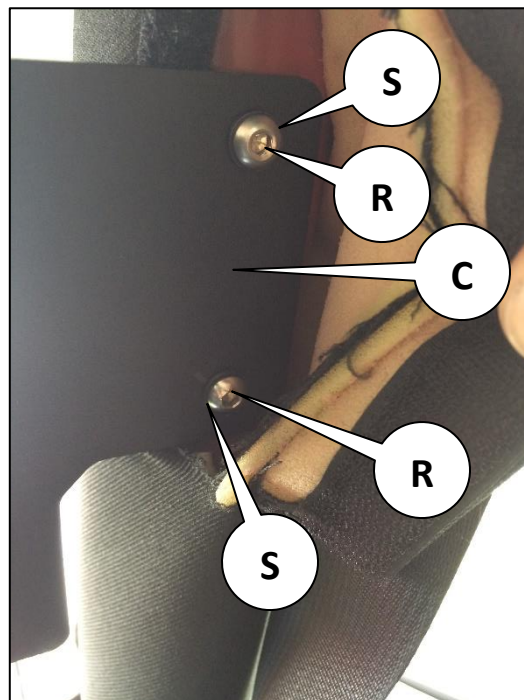

3 This step is for JL only, if you have a JK skip to step 5. Remove the plastic cover using the screwdriver on the driver side in the cargo area shown below to find the threaded holes.

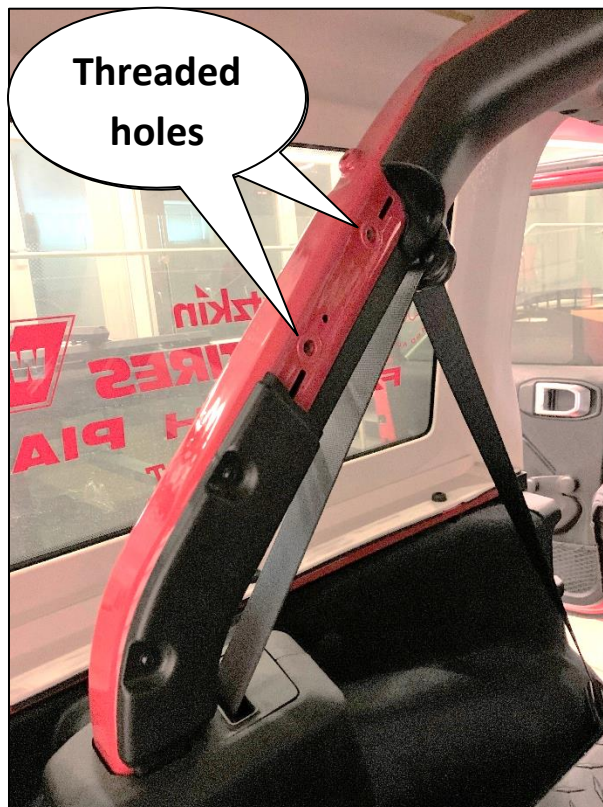

- 4** Install bracket (E) using bolts (M) and washers (N) into the threaded holes found in the previous step. Repeat steps 3&4 on the passenger side using bracket (F) instead.

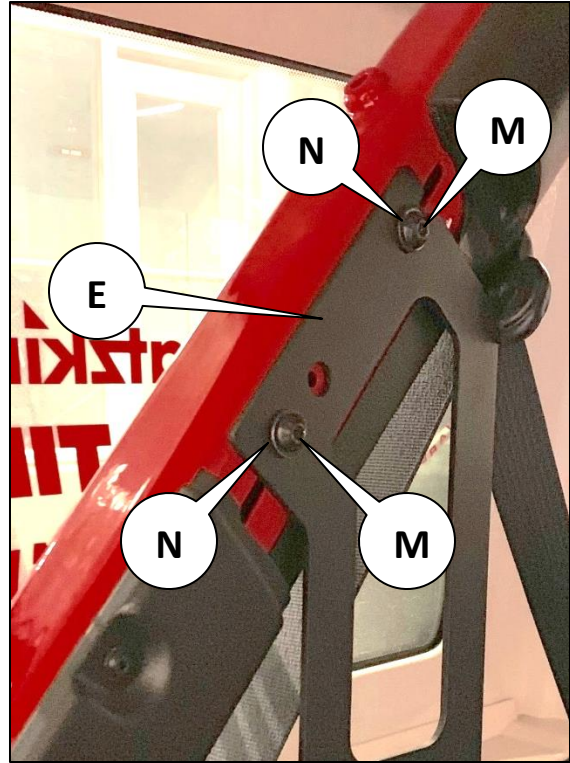

- 5** This step is for DZ 4470JP Steel Rack (A) only, if you have a DZ 4471JP Bolt Together Rack skip to step 6. Place steel rack onto brackets and use bolts (M), washers (N), and nuts (O), to install rack to brackets. Center the rack and tighten all hardware. Discard any extra hardware.

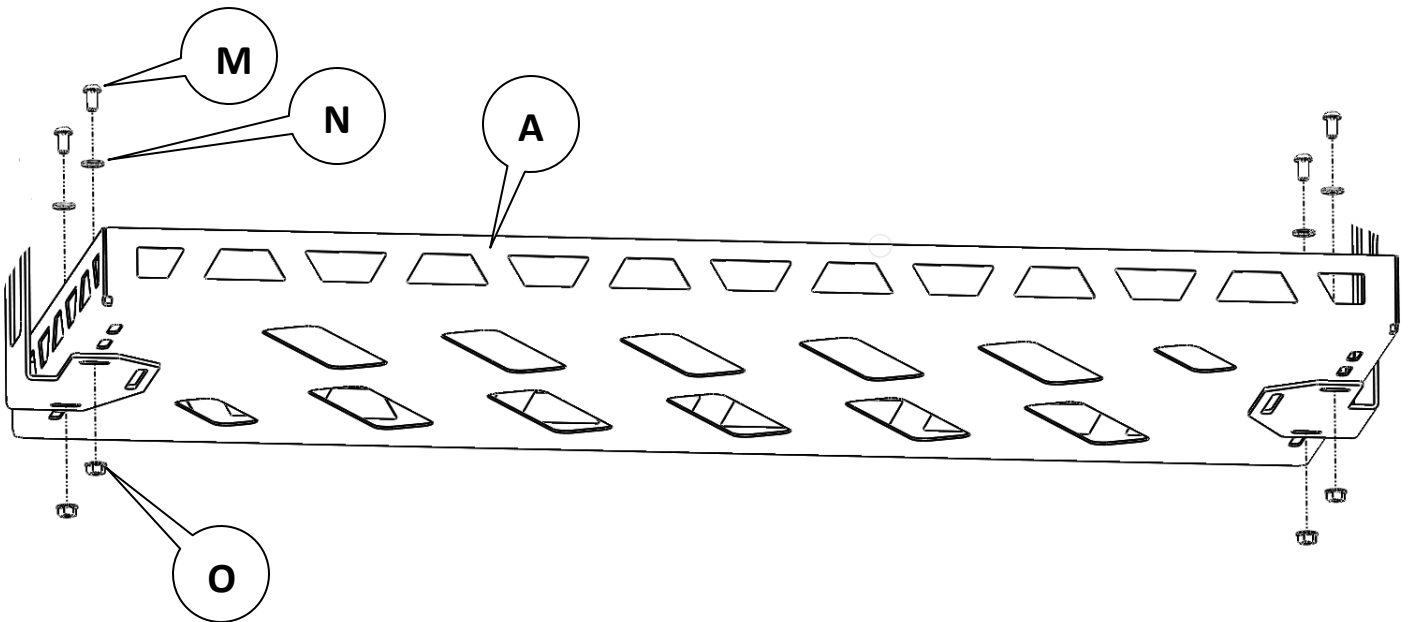

6

The rest of these instructions are for the DZ 4471JP Bolt Together Rack (B). First install bolts (P) and nuts (Q) into the slots of the brackets as shown below. Do not fully tighten at this time.

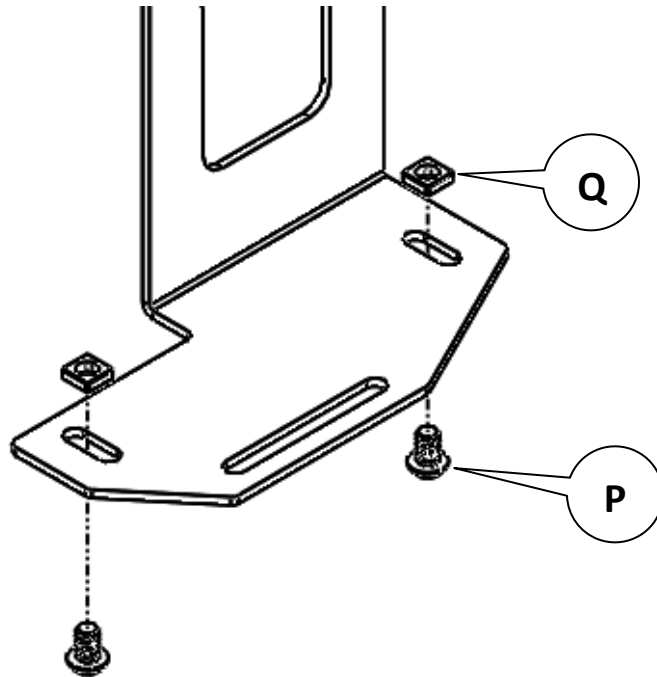

7

Install all endcaps (K) on the hex rails (G) by first hand pushing them to set in place, then hitting them with a rubber mallet.

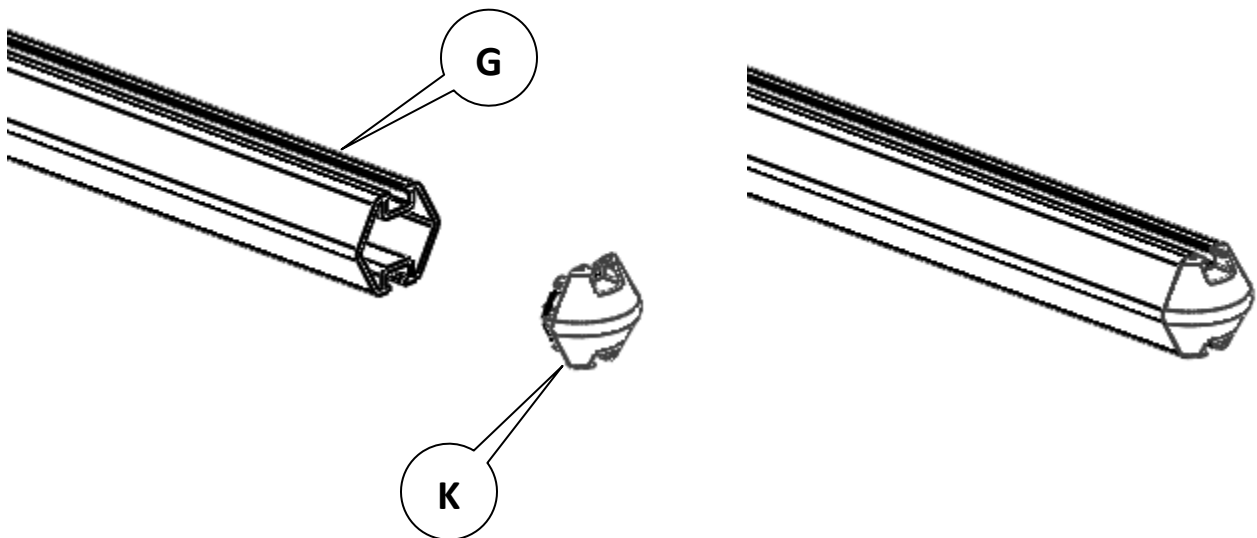

8

Slide the hex rails into the nuts from step 6.

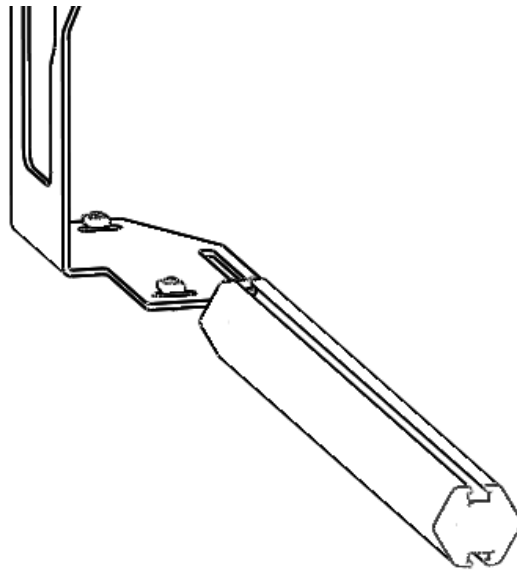

9

This Step is Optional. If you want tie downs, slide the tie down (L) onto the top side of the hex rails.

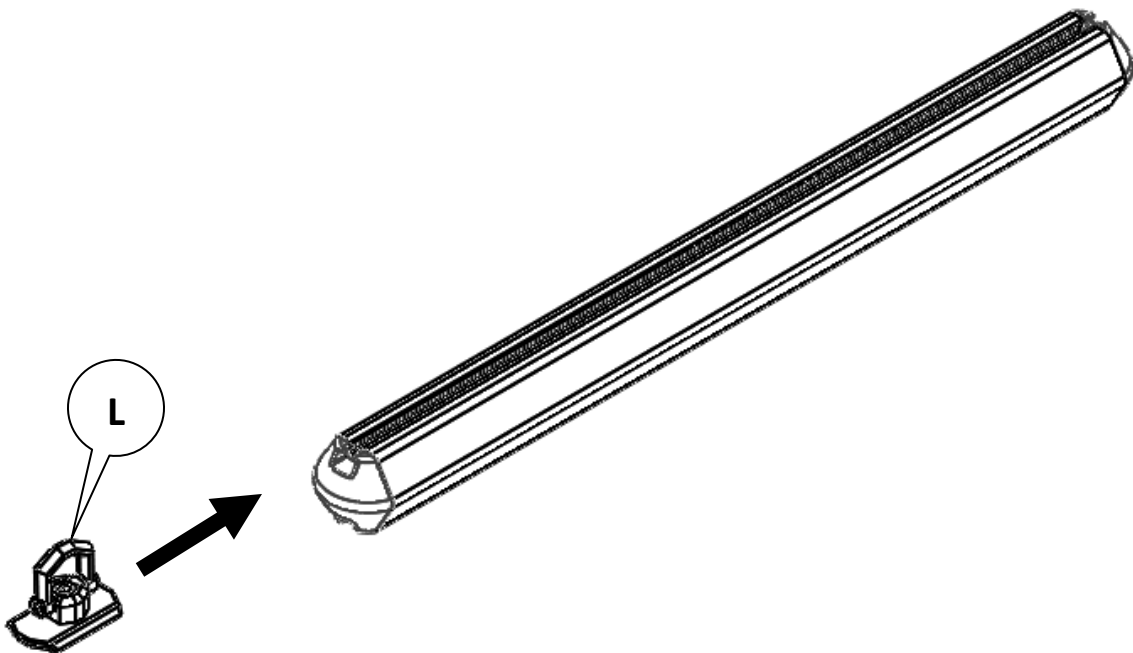

- 10** Preassemble the rack fences (H) using L-brackets (J), bolts (M&P), washers (N), and nuts (O&Q) shown below. Do not fully tighten at this time.

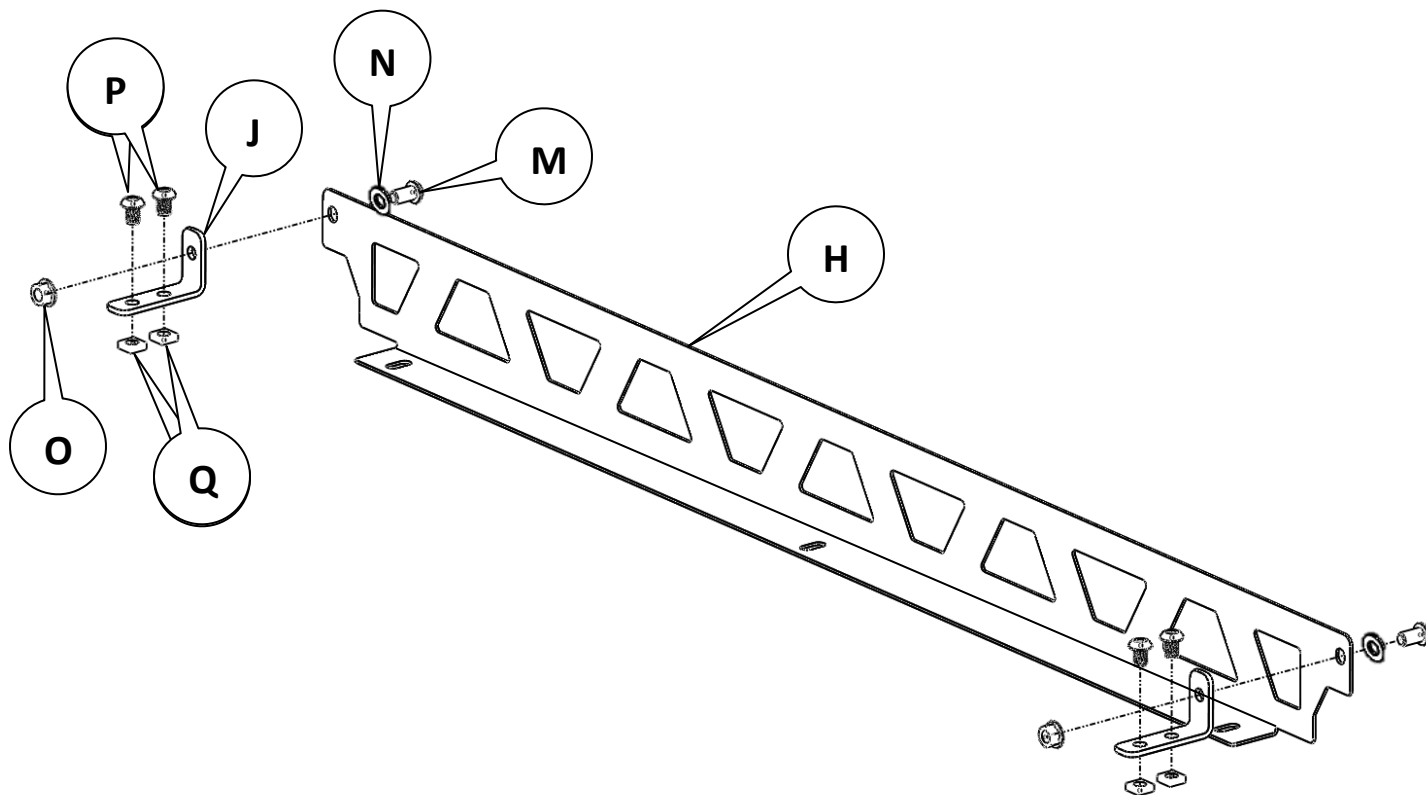

- 11** Slide the preassembled fences into the hex rails with the bends of the fences facing each other. The lower picture below is a side view of about where the fences and hex rails should be on the brackets.

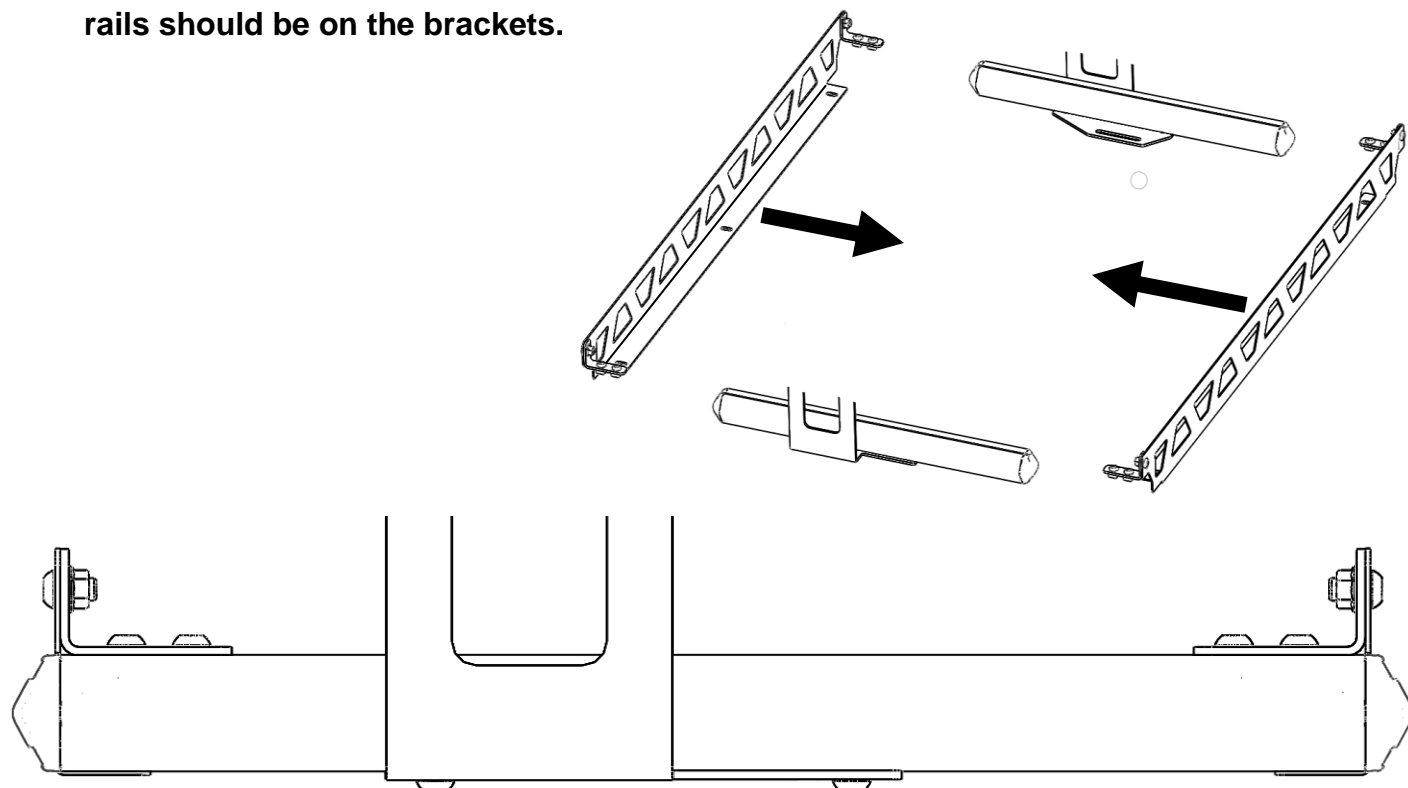

12

Drop in the decks (I) between the fences. If desired, one deck can be used instead of two. Ensure decks line up with slots in vehicle brackets and install bolts (M), washers (N), and nuts (O) into fences and through vehicle brackets to install. Center the rack and fully tighten all hardware at this time.

