

TCCAN859

Instructions



Carrier Basket



CITY CRASH
Complies with ISO norm



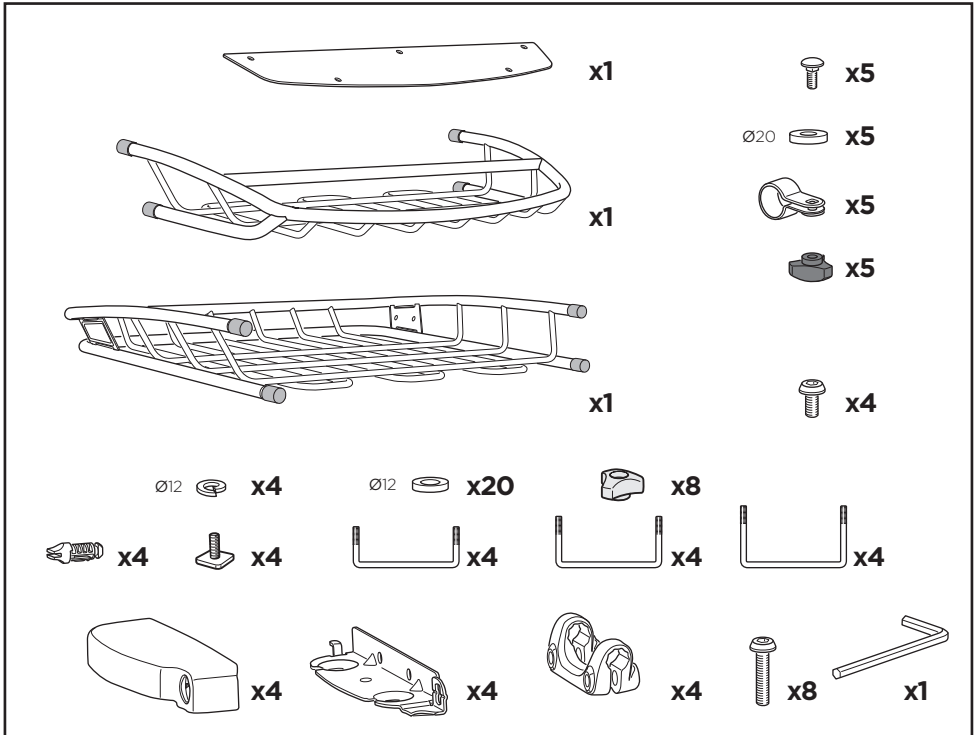
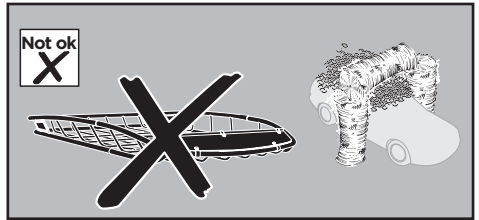
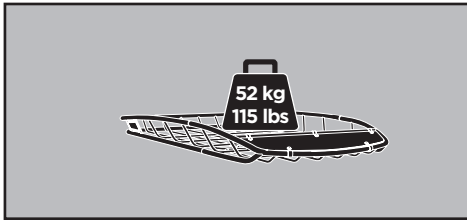
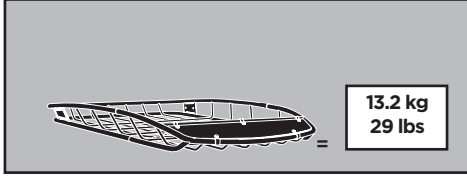
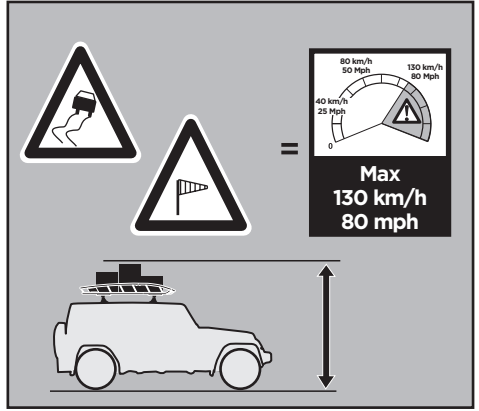
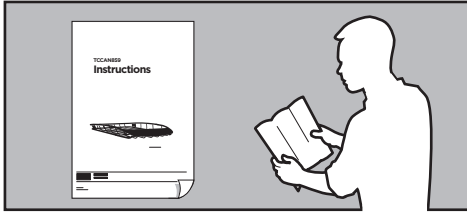

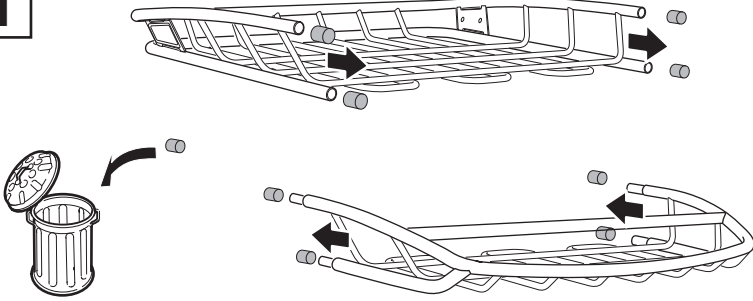
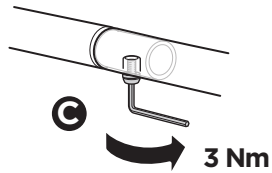
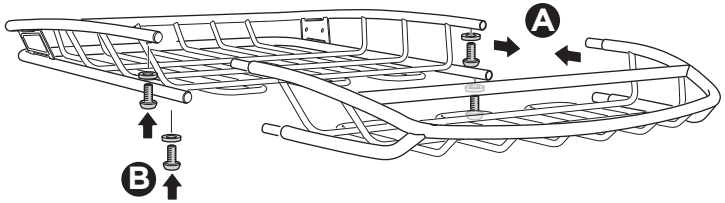
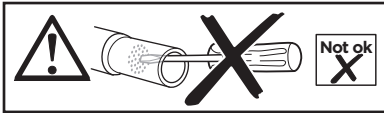
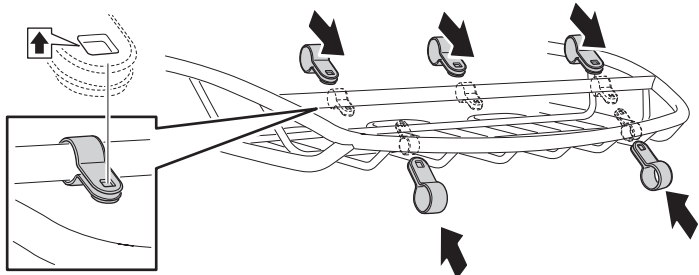
1**2****3**

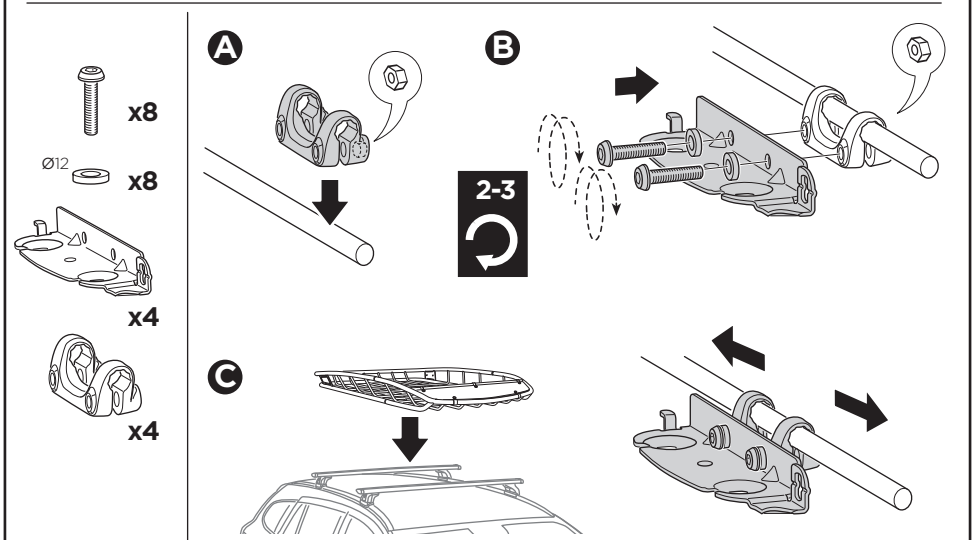
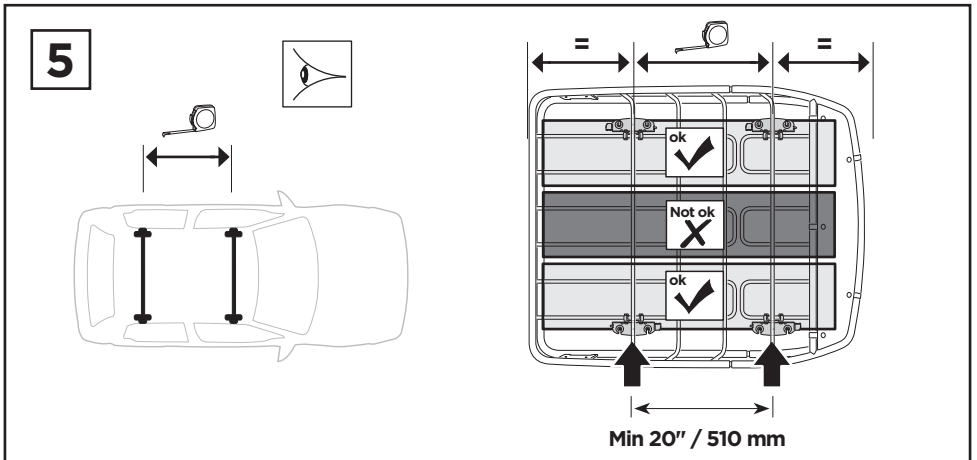
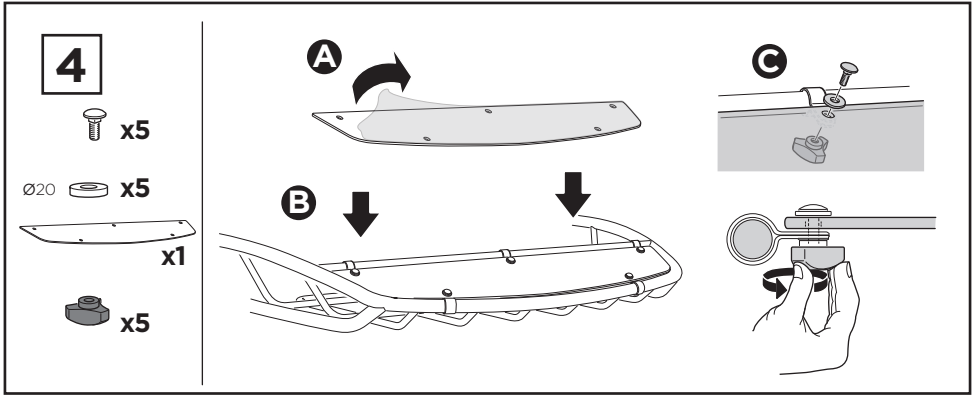

6a



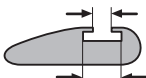

 x4
  x4
  x4

Max 1/2" / 12 mm

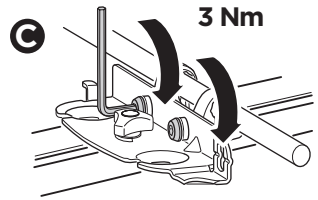
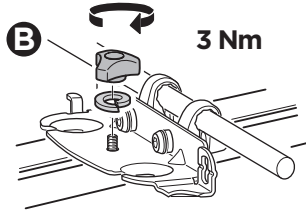
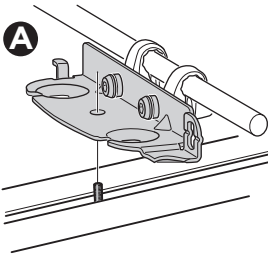
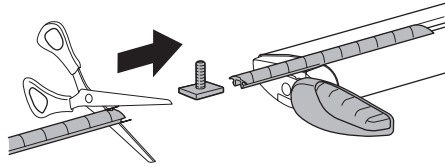

Max 7/8" / 22 mm

**6b**

 x4
  x4
  x4
 $\varnothing 12$
  x8
  x8

Max 3 1/2" / 90 mm

1 5/8" / 40 mm



Min 5/8" / 15 mm
Max 1" / 25 mm

Max 3 1/2" / 90 mm

2" / 50 mm

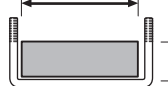

Min 1" / 25 mm
Max 1 3/8" / 35 mm

Max 3 1/2" / 90 mm

2 3/8" / 60 mm



Min 1 3/8" / 35 mm
Max 1 3/4" / 45 mm

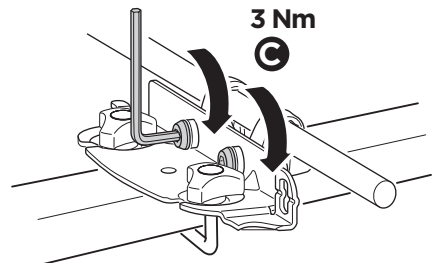
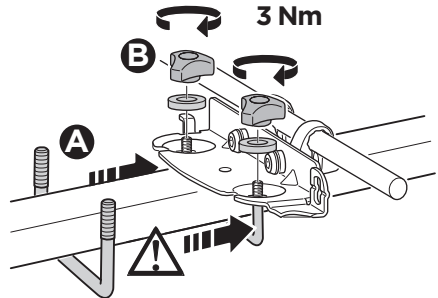

7

 x4

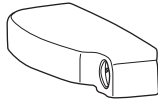
 x4

A

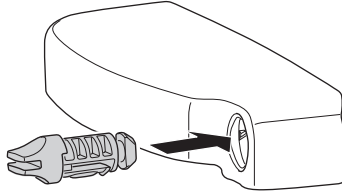

B

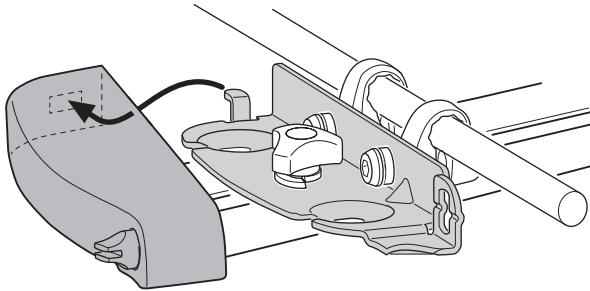

C

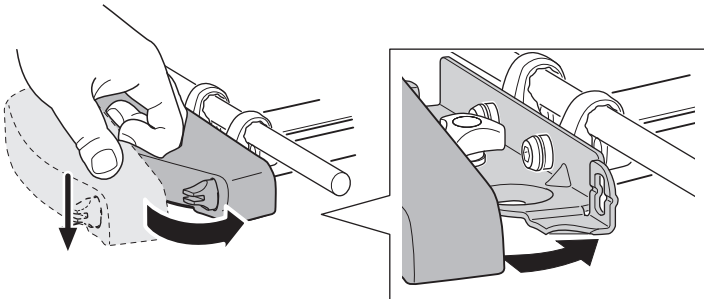

D

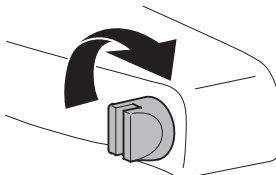

i

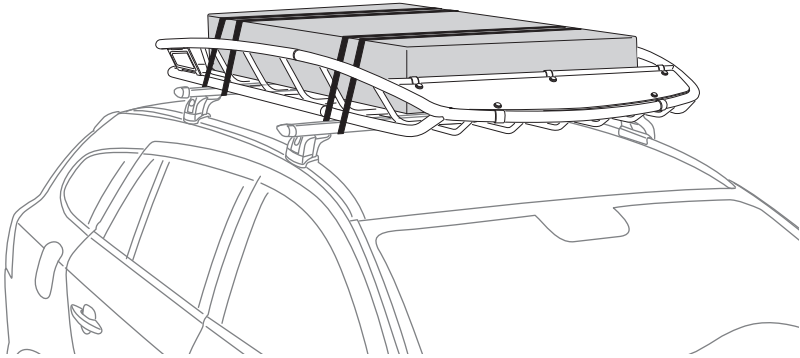
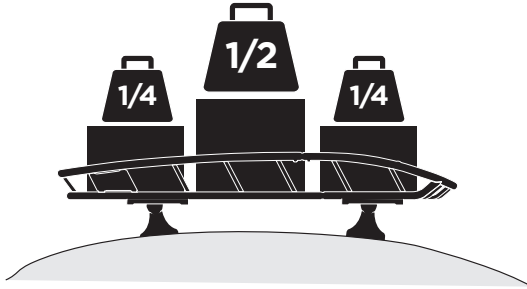



THULE.COM



Thule Sweden AB, Box 69, 330 33 Hillerstorp, SWEDEN
Thule Inc., 42 Silvermine Road, Seymour, Connecticut 06483, USA



info@thule.com
Phone: 800-238-2388



www.thule.com